

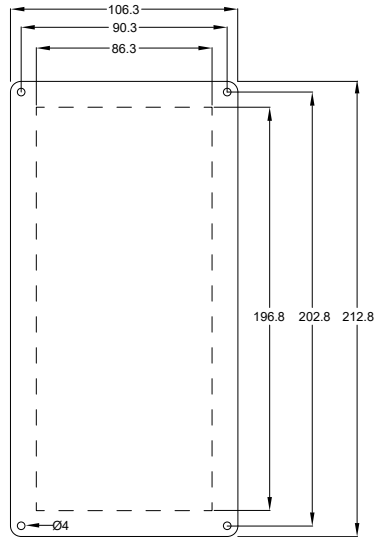

**CIRCUIT BREAKER PANEL**

Installation instructions for 8 way circuit breaker panel

1. Cut hole as per template (86.3mm x 196.8mm). Use 4 screws supplied to retain panel.
2. Connect positive wire from link bar to positive distribution bar (not supplied).
3. Connect positive wire from PCB to positive distribution bar (not supplied).
4. Connect negative wire from PCB to negative distribution bar (not supplied).
5. Connect positive wire from the selected appliance to breaker using 4.3mm ring terminal.

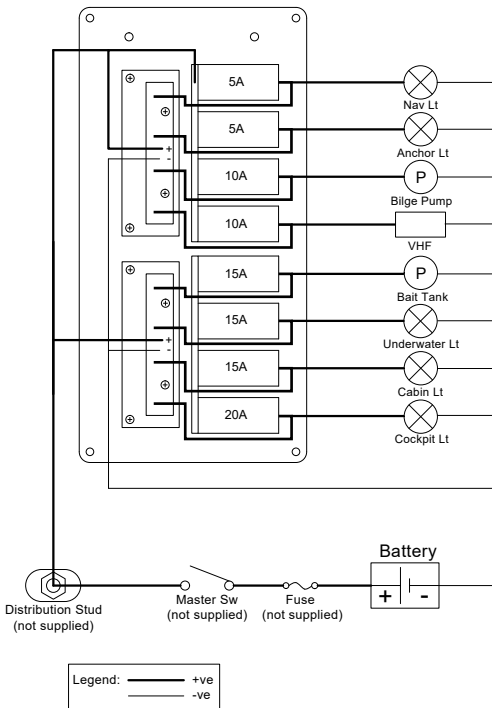

Dimensions in mm's

## Connex Product Warranty

### Our Product Guarantee

Connexwire stands behind its products for as long as you own them. Connexwire Limited will replace or issue a credit for any of its products found to be defective in materials or manufacture. No compensation will be allowed for products not returned to Connexwire for analysis, nor will compensation be made for labour required to replace any defective product. Please contact [info@connexwire.com](mailto:info@connexwire.com) for a product return reference prior to shipping any product back to Connexwire.